

GTP-602

Stereo Tuner/Preamplifier



ADCOM

ABOUT ADCOM

PERFORMANCE AND VALUE

In the world of high performance electronics, Adcom has done the impossible: make state-of-the-art components that are easy to use at an affordable price. In doing this, Adcom has created a revolution in the world of consumer electronics. By creating some of the most renowned components and offering them at affordable prices, Adcom has enabled more people to enjoy their favorite music and movies at top performance levels. Perhaps *Audio Magazine* said it best: "No competing company I know can provide a similar balance of sound quality, power and affordability."

AWARD WINNING

Innovation is our stronghold, and our numerous awards year after year prove that we're never satisfied to rest on our reputation. From our legendary high current amplifiers to our state-of-the-art digital processors, Adcom components consistently impress even the most demanding audiences. Adcom components have won over 25 Product of the Year and Special Recognition citations from Audio Video International, 3 Diapason D'Or Awards, 7 Consumer Electronics Show Design and Engineering Awards, and have appeared on Stereophile's "Recommended Components" lists over 70 times since 1988. A reputation worth its weight in gold.

ENGINEERING PASSION

Every Adcom component is not only designed to reproduce the highest quality sound and picture, but to also deliver the greatest possible value. It is our engineers' passion for perfection that has enabled our components to be judged the equivalent of others costing two, three, or even five times as much. Our engineering team consistently strives to develop and design products that will exceed your expectations. Our goal at Adcom is to let more consumers hear high-end quality sound and see high-end video without paying high-end prices.

All Adcom components are the result of a long-standing dedication to innovation, quality, simplicity and value. Adcom, we have the power, and now so do you.

ADCOM

A division of Klein Technology Group, LLC
8541 East Anderson Drive
Scottsdale, Arizona 85255 USA

Telephone: (480) 607-2277

Fax: (480) 348-9876

Email: info@adcom.com

Web: www.adcom.com

ADCOM is a registered trademark of Klein Technology Group, LLC.

Copyright © 2003 Klein Technology Group, LLC. All rights reserved. No part of this manual may be reproduced or electronically transmitted without the express written consent of Klein Technology Group, LLC.

TABLE OF CONTENTS

WELCOME	2
SAFETY INFORMATION	4
INTRODUCTION & UNPACKING	5
DESCRIPTION OF UNIT	
FRONT PANEL DRAWING	6
1.1 INTERFACE OVERVIEW	6-7
REAR PANEL DRAWING	8
1.2 INPUTS & OUTPUTS SYSTEM CONNECTIONS	8-9
REMOTE CONTROL DRAWING	10
2.1 OVERVIEW OF THE GRC-800	11
2.5 DISCRETE CUSTOM CODES FOR INSTALLERS	12
TROUBLESHOOTING	
RESOLVING PROBLEMS	13
TROUBLESHOOTING	14
SERVICE INFORMATION	14
WARRANTY	15
GTP-602 SPECIFICATIONS	16

THE FOLLOWING PRECAUTIONS AND SAFETY INSTRUCTIONS ARE REQUIREMENTS OF UL AND CSA SAFETY REGULATIONS

Warning: To reduce the risk of fire or electric shock, do not expose this unit to rain or moisture.

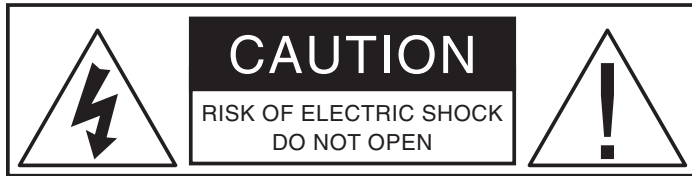

The graphic symbol of a lightning flash with an arrow point within a triangle signifies that there is dangerous voltage within the unit and it poses a hazard to anyone removing the cover to gain access to the interior of the unit. Only qualified service personnel should make any such attempt.

The graphic symbol of an exclamation point within an equilateral triangle warns a user of the device that it is necessary to refer to the instruction manual and its warnings for proper operation of the unit.

Do not place this unit on an unstable cart, stand, tripod, bracket, or table. The unit may fall, causing serious injury to a child or adult, and serious damage to the unit. Use only with a cart, stand, tripod, bracket, or table recommended by the manufacturer or sold with the unit. Any mounting of the device should follow the manufacturer's instructions, and should use a mounting accessory recommended by the manufacturer.

Read all the safety and operating instructions before connecting or using this unit.

Retain this notice and the owner's manual for future reference.

All warnings on the unit and in its operating instructions should be adhered to.

All operating and use instructions should be followed.

Do not use this unit near water. For example, near a bathtub, washbowl, kitchen sink, laundry tub, in a wet basement, or near a swimming pool.

The unit should be installed so that its location or position does not interfere with its proper ventilation. For example, it should not be situated on a bed, sofa, rug, or similar surface that may block the ventilation openings; or placed in a built-in installation, such as bookcase or cabinet, that may impede the flow of air through its ventilation openings.

The unit should be situated away from heat sources such as radiators, heat registers, stoves, or other devices (including amplifiers) that produce heat.

The unit should be connected to a power supply outlet only of the voltage and frequency marked on its rear panel.

The power supply cord should be routed so that it is not likely to be walked on or pinched, especially near the plug, convenience receptacles, or where the cord exits from the unit.

Clean unit only as recommended in its instruction manual.

The power supply cord of the unit should be unplugged from the wall outlet when it is to be unused for a long period of time.

Care should be taken so that objects do not fall, and liquids are not spilled, into the enclosure through any openings.

This unit should be serviced by qualified service personnel when:

- A. The power cord or the plug has been damaged; or
- B. Objects have fallen, or liquid has been spilled, into the unit; or
- C. The unit has been exposed to rain, or liquids of any kind; or
- D. The unit does not appear to operate normally, or exhibits a marked change in performance; or
- E. The device has been dropped, or the enclosure damaged.

**DO NOT ATTEMPT SERVICING OF THIS UNIT YOURSELF.
REFER SERVICING TO QUALIFIED SERVICE PERSONNEL.**

ATTENTION

POUR PREVENIR LES CHOCS ELECTRIQUES NE PAS UTILISER CETTE FICHE POLARISEE AVEC UN PROLONGATEUR, UNE PRISE CE COURANT OU UNE AUTRE SORTIE CE COURANT, SAUF SI LES LAMES PEUVENT ETRE INSEREES A FOND SANS EN LAISSER AUCUNE PARTIE A DECOUVERT.

CAUTION

TO PREVENT ELECTRIC SHOCK DO NOT USE THIS POLARIZED PLUG WITH AN EXTENSION CORD, RECEPTACLE OR OTHER OUTLET UNLESS THE BLADES CAN BE FULLY INSERTED TO PREVENT BLADE EXPOSURE.

CAUTION POWER LINES

Any outdoor antenna must be located away from all power lines.

OUTDOOR ANTENNA GROUNDING

If an outside antenna is connected to your tuner or tuner/preamplifier, be sure the antenna system is grounded so as to provide some protection against voltage surges and built-up static charges. Section 810 of the National Electrical Code, ANSI/NFPA No. 701984, provides information with respect to proper grounding of the mast and supporting structure, grounding of the lead-in wire to an antenna discharge unit, size of grounding conductors, location of antenna discharge unit, connection to grounding electrodes, and requirements for the grounding electrode.

- a. Use No.10 AWG (5.3 mm²) copper, No.8 AWG (8.4 mm²) aluminum, No.17 AWG (1.0 mm²) copper clad steel or bronze wire, or larger, as a ground wire.
- b. Secure antenna lead-in and ground wires to house with stand-off insulators spaced from 46 feet (1.221.83 m) apart.
- c. Mount antenna discharge unit as close as possible to where lead-in enters house.
- d. Use jumper wire not smaller than No.6 AWG (13.3 mm²) copper, or the equivalent, when a separate antenna grounding electrode is used. See NEC Section 810-21 (j).

EXAMPLE OF ANTENNA GROUNDING AS PER NATIONAL ELECTRICAL CODE INSTRUCTIONS CONTAINED IN ARTICLE 810. RADIO AND TELEVISION EQUIPMENT.

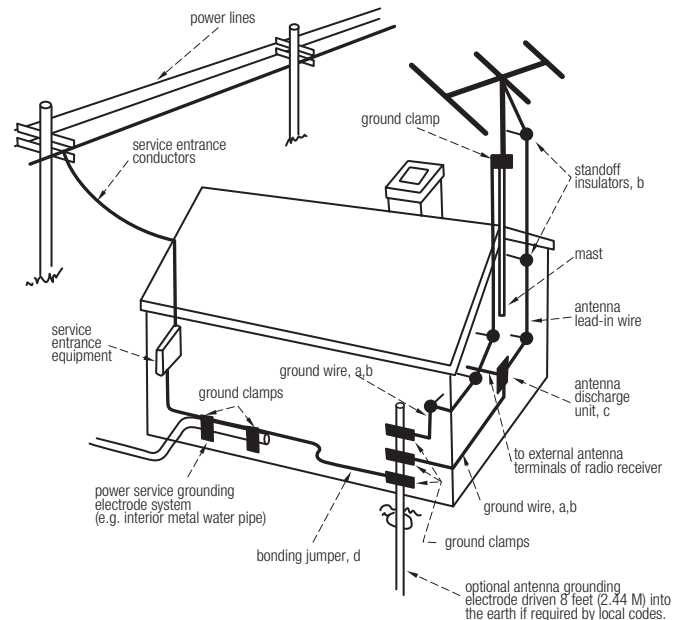

NOTE TO CATV SYSTEM INSTALLER

This reminder is provided to call the CATV system installer's attention to Article 82022 of the National Electrical Code that provides guidelines for proper grounding and, in particular, specifies that the cable ground shall be connected to the grounding system of the building, as close to the point of cable entry as practical.

Congratulations on your decision to purchase the GTP-602 tuner/preamplifier. Your new ADCOM component was designed to deliver incredible sound and years of reliable performance. Audition the GTP-602 paired with an ADCOM power amp and DVD player and you will experience what high performance is all about. To realize the full potential of your GTP-602, and before making any connections to it, please read these operating and installation instructions thoroughly.

Key Features

- RDS tuner
- Phono input stage
- RS 232 control
- Torriodial power transformer

Unpacking the GTP-602

Before your new ADCOM tuner-preamplifier left our factory, it was carefully inspected for physical imperfections and tested for all electrical parameters as a routine part of ADCOM's systematic quality control. This, along with full operational and mechanical testing, should ensure a product flawless in both appearance and performance. After you have unpacked the GTP-602, inspect it for physical damage. Save the shipping carton and all packing material as they are intended to reduce the possibility of transportation damage should the preamplifier ever need to be shipped again. In the unlikely event damage has occurred, notify your dealer immediately and request the name of the carrier so a written claim to cover shipping damages can be initiated. The right to a claim against a public carrier can be forfeited if the carrier is not notified promptly in writing and if the shipping carton and packing materials are not available for inspection by the carrier. Save all packing materials until the claim has been settled.

Placing the GTP-602

Although the GTP-602 does not generate much heat, it is good practice to provide adequate ventilation for the unit. Therefore, the GTP-602 should be kept away from external sources of heat such as radiators and hot-air ducts.

We recommend that you exercise care when placing components on top of the GTP-602. If you are placing a heat producing component (such as an amplifier) on top of or below the GTP-602, it is recommended that you allow at least three (3) inches vertical spacing for proper airflow.

We also recommend that you leave five (5) inches of space behind the unit for additional airflow and to allow space for interconnects to hang freely.

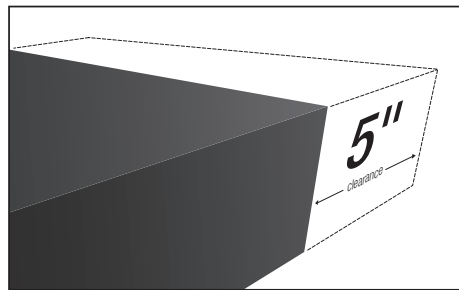

If you observe these recommendations, the GTP-602 will perform reliably in any reasonable environment. You should also pay attention to such normal considerations as protection from excessive dust and moisture.

The optimal performance of your new GTP-602 will ultimately depend on the care with which you make the connections between the amplifier, preamplifier and loudspeakers. All input and output signal connections should be made only with high quality, low-loss, low capacitance cables. For recommendations of the type and quality of interconnections that are best for your applications, consult with your ADCOM retailer.

Safety Information

There are no user serviceable parts inside. Refer all servicing to qualified service personnel.

The unit must be connected to a power supply only of the type and voltage specified on the rear panel. Connect the component to the power outlet only with the supplied power supply cable or an exact equivalent. Do not modify the supplied cable. Do not defeat grounding and/or polarization provisions. The cable should be connected to a 3-pin polarized wall outlet, matching the wide blade of the plug to the wide slot of the receptacle. Do not use extension cords. Do not route the power cord where it will be crushed, pinched, bent, exposed to heat, or damaged in any way. Pay particular attention to the power cord at the plug and where it exits the back of the unit. The power cord should be unplugged from the wall outlet if the unit is to be left unused for a long period of time. Immediately stop using the component and have it inspected and/or serviced by a qualified service agency if:

- the power supply cord or plug has been damaged;
- objects have fallen or liquid has been spilled into the unit;
- the unit has been exposed to rain;
- the unit shows signs of improper operation; or
- the unit has been dropped or damaged in any way.

GTP-602 Front Panel

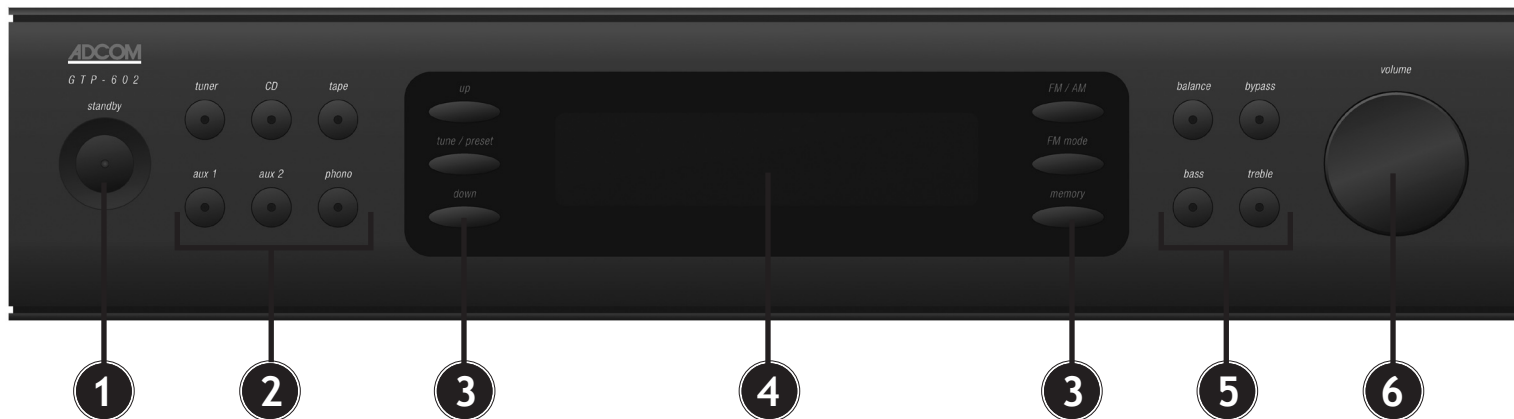

[1] Power Button

[2] Source Buttons

[3] RDS Tuner Buttons

[4] Power Button

[5] Equalization

[6] Volume knob

Description of Unit

1.1 Interface Overview

The GTP-602's front panel is designed for ease of operation. All controls are logically grouped for easy, intuitive operation. Familiarize yourself with the preceding diagram and read the short explanations of each feature below. When you finish, you will be well on your way to enjoying the GTP-602's convenience and sound quality.

[1] Power Button

The power button on the front panel toggles the unit between the "on" mode and the "stand-by" mode. For the GTP-602 to be in the "on" or "standby" mode, the rear panel power switch must be in the on position (see next section for details). In the "on" mode the LED in the power button will be red and the front panel display will be illuminated, in the "stand-by" mode the LED will be amber and the front panel display will be off. If the unit is in the "standby" mode, the remote control can be used to switch the unit on.

NOTE: In stand-by mode the GTP-602 uses very little power. However, it is recommended that you switch the unit completely off, using the rear panel switch if it is not going to be used for more than a couple of days. When the GTP-602 is plugged into the wall, current may still be flowing into the transformer. Only when the GTP-602 is unplugged is all current into the device stopped.

[2] Source Buttons

The source buttons are used to select the device to which you would like to listen. The LED in the button of the active source will be illuminated.

[3] RDS Tuner Buttons

These buttons are utilized to control the AM/FM tuner. The RDS tuner overview provides more detail on their operation.

[4] Display Window

The display area shows all vital information when the unit is operational.

[5] Equalization Buttons

These buttons provide control of adjustments to bass, treble and the balance functions. To adjust these functions, first push the treble, bass or balance button, then use the up/down buttons to the left of the display to make the desired change. In the bypass mode the bass and treble circuits are removed from the circuit path.

[6] Volume Knob

The Volume control adjusts the overall loudness of the signals being fed to the preamplifier outputs. Unlike conventional controls, the GTP-602's volume control doesn't have a start or end position. Volume can also be adjusted from the remote control using the volume up or down buttons. The Volume control does not affect recordings made using the Tape outputs. Volume setting can range from -80dB to +10dB.

RDS Tuner Overview

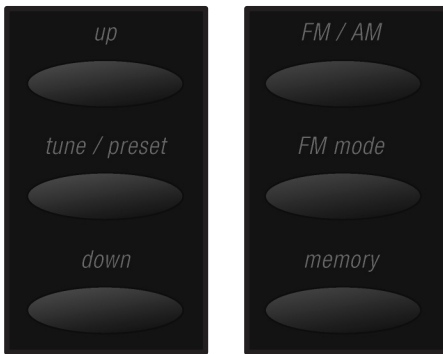

FM/AM Button: Toggles between AM and FM frequency bands.

FM mode Button: Sets the FM tuner to mono mode. The word mono appears next to the tuner preset number in the front panel display. Pressing the button again returns the FM tuner to stereo mode.

memory Button: This button is used to program preset stations. See the instructions following for more information.

tune/preset button: This button toggles the tuner between the direct tuning mode and the preset selection mode.

Up and Down Buttons: The function of these buttons depends on the tuning mode selected with the tune/preset button.

In preset mode (indicated in the display area): Press the down button to scroll to a lower number preset; press the up button to scroll to a higher preset number. This is a “wrap-around” function, so that going from the highest number preset, the tuner will go to the lowest preset number or vice-versa when tuning either up or down.

In tune mode: Press the up or down button to adjust the frequency currently being received. You can also press and hold the buttons to make faster adjustments.

The GTP-602 tuner can receive AM, FM and FM stereo broadcasts. Up to 24 stations can be preset and accessed from the front panel or

remote. Stations can also be tuned manually.

NOTE: Tuner reception cannot take place unless an appropriate AM and/or FM antenna is connected to the rear panel of the GTP-602.

To operate the tuner:

1. Press the tuner button on the remote control once, or press the tuner button on the front panel.
2. Press the AM/FM button on the remote control or the front panel to change between AM and FM bands.
3. Use the tune buttons on the front panel or the remote to change the tuner frequency. The new frequency will be displayed to the right of the FM or AM indicator.
4. Press and hold either the tune buttons on the front panel or on the remote to scan continuously up or down the selected band.
5. Press the FM mode button on the front panel to toggle between stereo and mono.

If an FM station produces lots of noise or sound that cuts in and out while in stereo, use the FM mode button to switch from stereo to mono.

To preset a radio station into memory:

1. Tune to the radio station you desire.
2. Press and hold the mem button on the remote or the memory button on the front panel for 3 seconds to store a station into a preset location. The display will change to show the word “memory” along with a flashing number.
3. Use the up or down buttons to select the preset number that you wish program. This programs the current radio station to that memory location. You have approximately five seconds to enter a number.

Listening to a radio station that you have preset:

1. Set the GTP-602 to tuner.
2. Use the keypad on the remote control to select the preset that you want to hear.

The tuner frequency changes to the new station in the preset memory of the GTP-602.

To change a preset radio station:

1. Tune to the new radio station you desire.
2. Press and hold the mem button on the remote or the memory button on the front panel. The display will change to show the word “memory” along with a flashing number.
3. Enter the new preset/memory location (01 through 12) using the keypad on the remote or the up and down buttons. This replaces the previously memorized preset with your new selection. You have approximately five seconds to enter a number.

GTP-602 Rear Panel

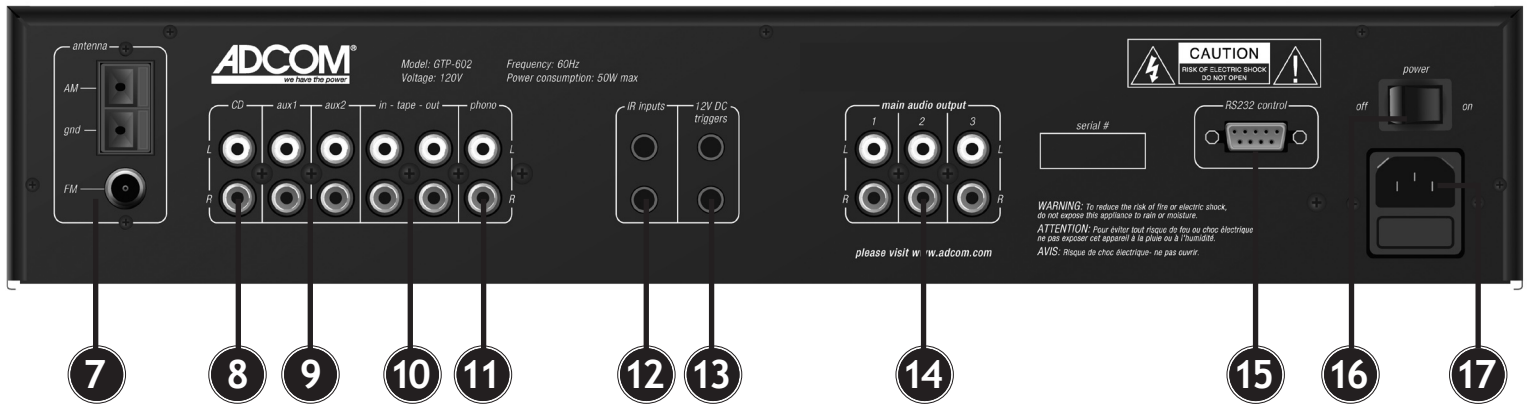

[7] Antenna Connections

[8] CD Analog Inputs

[9] Auxiliary Analog Inputs

[10] Tape Inputs/Outputs

[11] Phono Input

[12] IR Input

[13] 12V DC Trigger

[14] Main Audio Outputs

[15] RS232 Control Input

[16] Power Switch

[17] AC Power Input

1.2 Inputs & Outputs System Connections

Like the front panel, the GTP-602's rear panel is carefully arranged to make hookup, configuration, and use as simple as possible. However, the GTP-602's capabilities take some study to use most effectively. We strongly suggest that you read this section of the manual before beginning to hook up your system. You will save yourself much time and effort if you carefully think out what you expect from your system: consider the components you will use, where they'll be placed, and how you will want them to work together. The diagrams and notes in this section will probably answer most of your questions about interfacing the GTP-602 with other components in your system.

Note that the GTP-602's RCA-style jacks have color-coded centers to make connections easier. Use this key to help route cables properly:

RED centers = RIGHT CHANNEL ANALOG AUDIO inputs or outputs

WHITE centers = LEFT CHANNEL ANALOG AUDIO inputs or outputs

[7] Antenna Connections

AM Antenna: An AM loop antenna is supplied with the GTP-602 and is required for AM reception. Open the clip terminal lever and insert the wire from the antenna. Closing the lever will lock the wire in place. Test various positions for the antenna, but always ensure the loop is placed vertically for best reception. Placing the antenna close to large metal items such as metal shelves or radiators may interfere with reception.

NOTE: When reception is not satisfactory using the supplied AM loop antenna alone, connection of an external antenna is recommended. The antenna cable to the loop antenna must not exceed three meters.

FM Antenna: A ribbon wire FM antenna is included and should be connected to the FM connector at the rear of the unit using the adapter supplied. The ribbon aerial should be mounted on a vertical surface and placed so that it forms a 'T'.

Experiment with placement of the antenna to find the position that gives the best signal strength and lowest background noise. An inadequate FM signal normally results in high levels of hiss, especially in stereo, and interference from external electrical sources. In areas of poor FM reception, the tuner section's performance can be improved by using an externally mounted FM antenna. A qualified aerial installer will be able to advise and fit a recommended aerial for your reception conditions.

[8] CD Analog Inputs

Input for CD player (analog audio signal) or other line-level signal source.

Use a twin RCA-to-RCA lead to connect the CD player's left and right 'Audio Outputs' to this input.

[9] Auxiliary Analog Inputs

Input for any line-level signal source. Use a twin RCA-to-RCA lead to connect the CD player's left and right 'Audio Outputs' to this input.

[10] Tape Inputs/Outputs

Connections for analog recording and playback to an audio tape recorder of any type, such as a cassette, reel-reel, DAT, MD or CD-R. Using twin RCA-to-RCA leads, connect to the left and right 'Audio Output' of the tape machine to the TAPE IN connectors for playback. Connect the left and right 'Audio Input' of the tape machine to the TAPE OUT connectors for recording.

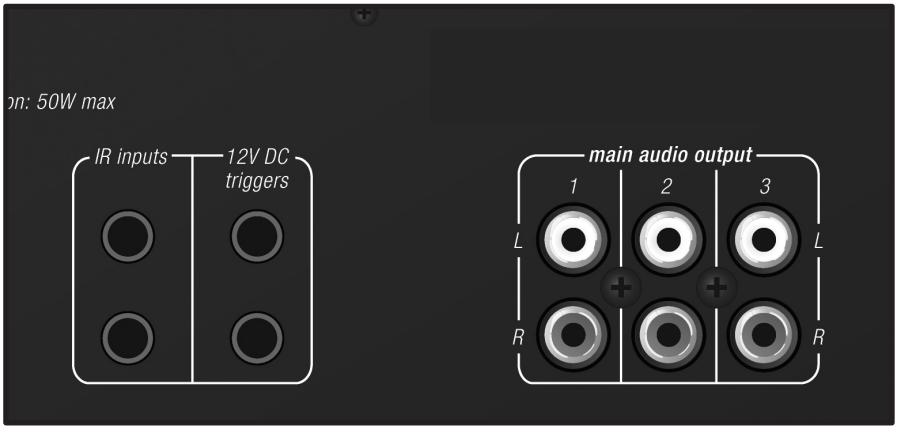

[13] 12V DC Trigger

To facilitate remote turn-on and turn-off of other components (power amplifiers, for example), this 3.5mm mini-jack provides a constant signal (12 volts DC) whenever the GTP-602 is fully powered. When the GTP-602 is turned off (via the front panel switch) or placed in standby mode (via the

[16] Power Switch

The rear panel power switch should be turned off if the system will not be in use for an extended period of time. When the power switch is in the off position the GTP-602 is not using any power from the AC wall circuit. This switch must be on for the GTP-602 to operate in the "stand-by" mode.



[11] Phono Inputs

Input for a phono (record) player (analog audio signal) Use a twin RCA-to-RCA lead to connect the phono-player's left and right 'audio outputs' to this input.

[12] IR Input

The IR input allows hook up of an external IR sensor that sends IR information to the microprocessor in the GTP-602. This feature can be very useful if the GTP-602 is placed behind a non transparent door or is used with an after market remote control system.

"power" button on the remote control), the jack has no output.

[14] Main Audio Outputs

Before making any connections, check that the GTP-602 and the power amplifiers it will be connected to are switched off. Connect the RCA-to-RCA leads from the GTP-602 to your external amplifiers. The three pairs of outputs all carry the same signal.

[15] RS232 Control (DB 9)

Allows control of the GTP-602 via computer or home automation system.

[17] AC Power Cord

After you have completed all connections to the amplifier, plug the AC line cord into a "live" wall socket. Use only the supplied power cord or equivalent.

GRC-820 Remote Control

[18] Power Button

[19] RDS Button

[20] Tuner Preset Buttons

[21] Scan Button

[22] Bass and Treble

[23] Bypass

[24] Balance Control

[25] GDV-850 Control

[26] Volume Up

[27] Volume Down

[28] Mute

[29] Tune Up

[30] Tune Down

[31] AM/FM

[32] FM Mode

[33] Tune/Preset

[34] Memory

[35] Sources

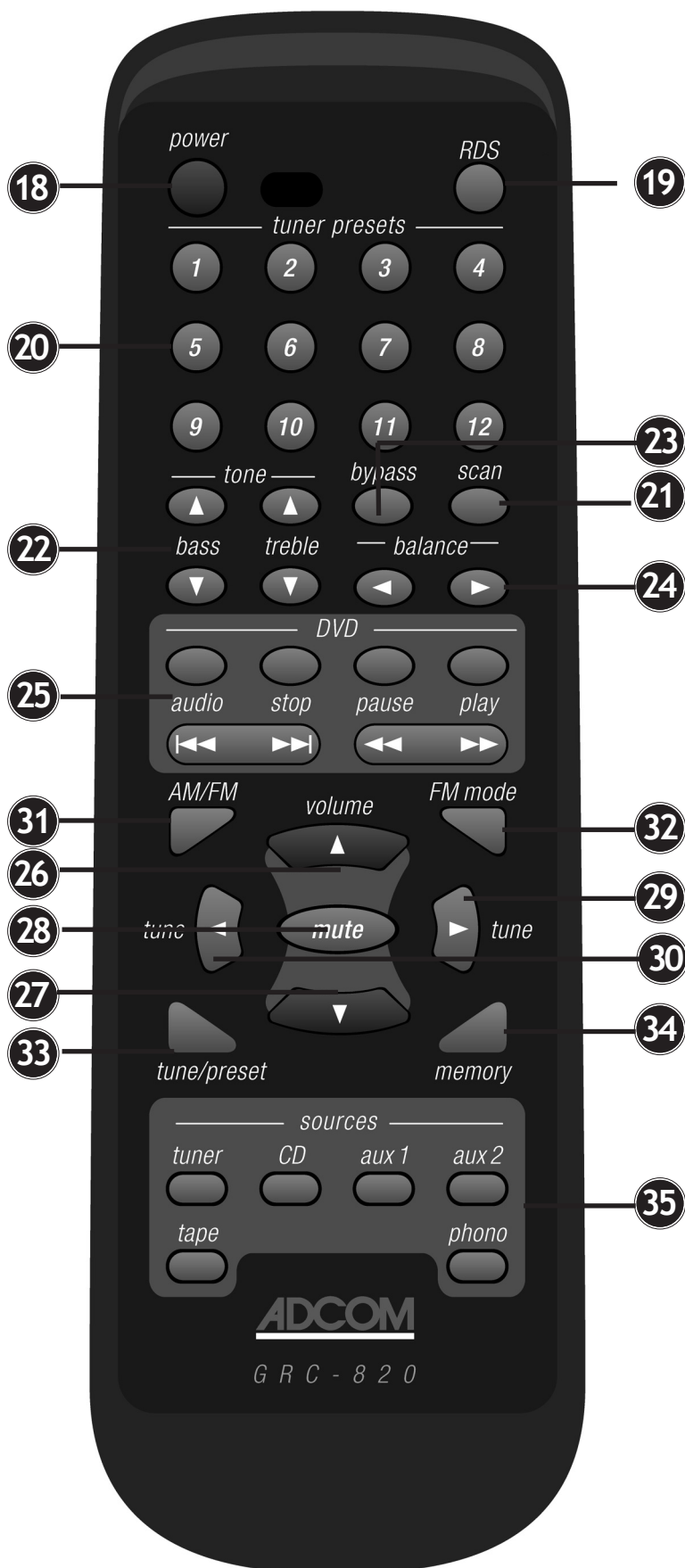

2.1 GRC-820 Overview

The GRC-820 is designed specifically for use with the GTP-602. We hope you find the layout of the controls simple to use. Note, there are also controls for use with an ADCOM DVD player, should you wish to utilize our GDV-850 in your system with the GTP-602. The following text provides information on each functional area of the the GRC-820.

The GRC-820 needs two AAA batteries which are installed into the back of the remote control. Alkaline batteries are recommended for maximum operating life. When replacing batteries, check that they have been put in correctly, as indicated on the base of the battery compartment.

[18] Power Button

This button toggles the GTP-602 between the "on" mode and the "stand-by" mode. Note, the rear panel power switch on the GTP-602 must be in the on position for the GRC-820 to control the GTP-602

[19] RDS Button

When listening to FM radio stations that broadcast RDS data, the RDS button displays the information made available using the Remote Data System on the front panel of the GTP-602. This information can be the format of the radio station or song specific. The information you will receive is determined by the broadcaster.

[20] Tuner Presets

These buttons provide direct access to both FM and AM presets that are programmed into the GTP-602.

[21] Scan Button

This button engages the scan function which provides a brief listening preview to all the preset stations. Press the button again to end the function.

[22] Bass and Treble

These buttons provide access to the

bass and treble adjustments. The adjustment range is from +8dB to +10dB.

[23] Bypass

The bypass button provides a more direct signal path that reroutes the audio signal around the bass and treble adjustment circuits, thus providing a cleaner sound. The bass and treble functions are not in the circuit when the bypass mode is engaged.

[24] Balance Control

This control moves the center image between the left and right speakers and can be used to correct for center image localization.

[25] DVD Player Control

These buttons provide control for an ADCOM DVD player such as the GDV-850.

[26] Volume Up

This button increases the level of the sound you hear from your system.

[27] Volume Down

This button decreases the level of the sound you hear from your system.

[28] Mute

This button "turns off" the sound coming from your system. Push the button a second time to restore the previous level.

[29] Tune Up

This button is used to change the radio station. It functions in both the preset mode and the tune mode.

[30] Tune Down

This button is used to change the radio station. It functions in both the preset mode and the tune mode.

[31] AM/FM

This button toggles the tuner between the FM and AM setting.

[32] FM mode

The FM mode button toggles the GTP-602 between the stereo and mono reception mode while listening to FM radio.

[33] Tune/Preset

This button toggles the tuner between the direct tuning and the preset station mode.

[34] Memory

This button is used to store tuner presets.

[35] Sources

These buttons are used to select the device to which you would like to listen.

IR Command List for ADCOM GTP-602

1AE5h: Custom Code(A)

Code:NEC

Button	HEX	DECIMAL
Power	0x80	128
CD	0x88	136
tuner	0x89	137
tape	0x8A	138
aux 1	0x8B	139
aux 2	0x84	132
phono	0x86	134
volume up	0xD5	213
volume down	0xD1	209
mute	0x82	130
balance left	0xD9	217
balance right	0xDA	218
treble up	0x58	88
treble down	0x59	89
bass up	0x5A	90
bass down	0x5B	91
bypass	0x4D	77
AM/FM	0x8F	143
tune/preset	0xCD	205
tune up	0x8C	140
tune down	0x8D	141
FM mode	0xCE	206
rds	0x02	2
memory	0x0B	11
preset scan	0xD3	211
tuner preset 1	0x90	144
tuner preset 2	0x91	145
tuner preset 3	0x92	146
tuner preset 4	0x93	147
tuner preset 5	0x94	148
tuner preset 6	0x95	149
tuner preset 7	0x96	150
tuner preset 8	0x9C	156
tuner preset 9	0x9D	157
tuner preset 10	0x9E	158
tuner preset 11	0x9F	159
tuner preset 12	0xDC	220

1AE8h: Custom Code(B)

Code:NEC

Function	HEX	DECIMAL
Power On	0x54	84
Power Off	0x55	85
Mute On	0x56	86
Mute Off	0x57	87
Bypass On	0x16	22
Bypass Off	0x17	23
AM	0xC9	201
FM	0xCA	202
Tune mode	0x8B	139
Preset Mode	0xC8	200
FM mono mode	0x14	20
FM stereo mode	0x15	21

SYMPTOM	POSSIBLE REASON	POSSIBLE SOLUTION
No sound	<ul style="list-style-type: none"> • Power AC lead unplugged or power not switched on • Tape Monitor selected • Mute on • Power Amplifier not on 	<ul style="list-style-type: none"> • Check if AC lead is plugged in and power switched on • De-select Tape Monitor mode • Switch off Mute • Turn on the Power Amplifier
No sound on one channel	<ul style="list-style-type: none"> • Speaker not properly connected or damaged. • Input lead disconnected or damaged 	<ul style="list-style-type: none"> • Check connections and speakers • Check leads and connections • Select appropriate Surround mode (large or small)
No sound on surround channels (for digital preamplifiers)	<ul style="list-style-type: none"> • No surround mode selected • Mono sound source • Speakers not properly connected • Surround volume level too low 	<ul style="list-style-type: none"> • Select a Surround Mode • Test system with Stereo or Dolby Surround material • Check speakers and connections • Increase surround volume level
No sound on center channel (for digital preamplifiers)	<ul style="list-style-type: none"> • In Setup "OFF" for center speaker selected • Speaker not connected properly • Center volume level set too low 	<ul style="list-style-type: none"> • Select appropriate Center mode (large or small) • Check speaker and connection • Increase center volume level
"Dolby Digital" OR "DTS" auto-detection in digital preamp.	<ul style="list-style-type: none"> • Source not connected using digital input • Bit Stream is PCM 	<ul style="list-style-type: none"> • Connect digital output of source to GTP-602 • Check source material
Weak bass/Diffuse stereo image	<ul style="list-style-type: none"> • Speakers wired out of phase 	<ul style="list-style-type: none"> • Check connections to all speakers in the system
Remote control handset not working	<ul style="list-style-type: none"> • Batteries dead, or incorrectly inserted • IR transmitter or receiver windows obstructed • IR receiver in direct sun or very bright ambient light 	<ul style="list-style-type: none"> • Check or replace batteries • Remove obstruction • Place unit away from direct sun, reduce amount of ambient light
No sound with tuner	<ul style="list-style-type: none"> • Antenna leads incorrectly connected • Station not selected or weak signal with FM Mute on. 	<ul style="list-style-type: none"> • Check antenna connections to preamplifier • Re-tune or switch off FM Mute
Noise, hiss on AM and FM	<ul style="list-style-type: none"> • Weak signal 	<ul style="list-style-type: none"> • Check station tuning. Adjust or replace antenna.
Distortion on FM	<ul style="list-style-type: none"> • Multi-path signals or interference from another station 	<ul style="list-style-type: none"> • Check station tuning. Adjust or replace antenna
Whistles or buzzes on FM & AM	<ul style="list-style-type: none"> • Interference from other electrical sources - computers, games consoles 	<ul style="list-style-type: none"> • Check station tuning. Switch off or move the source of the electrical noise
Whistles or buzzes on AM	<ul style="list-style-type: none"> • Interference from fluorescent lighting or electrical motor 	<ul style="list-style-type: none"> • Check station tuning. Adjust or replace AM antenna
No RDS name (PS)	<ul style="list-style-type: none"> • Station signal too weak. • Station not transmitting RDS data 	<ul style="list-style-type: none"> • Check station tuning. Adjust or replace antenna • No remedy

Troubleshooting

Use the troubleshooting notes above to solve common situations that don't require professional attention. If the steps stated in possible solution do not resolve your problem, then please contact your ADCOM dealer or call the ADCOM customer service department. Any problems not covered here should be brought to the attention of your ADCOM dealer or ADCOM customer service department.

A special note on "hum:" When there is a low-volume "hum" audible throughout your speakers, even with the main volume turned all the way down, you have a common phenomenon known as a "ground loop." A ground loop is basically a difference in ground voltages between two or more components which are connected electrically and which creates multiple current paths where there must only be one. This difference in potentials creates a 60Hz low-level sound (approximately a low A), that seems to "hum."

It can be caused by adding new components to your system, but that does not imply there is anything electrically wrong with any new component. With the advent of audio/video and home theater systems, the problem has become commonplace. Generally, the cause is the Cable-TV incoming signal line. This new incoming line may add an additional ground at a different potential to the AC line ground of your other equipment (refer to note 1 and 2, to troubleshoot a hum problem).

Note 1: Cable TV systems can sometimes contribute to ground loop problems which cause "hum." To determine if your cable system is the contributing factor, disconnect the Cable-TV incoming signal line (round, 75Ω) at the wall,

or the first component the cable is connected to (i.e. the cable box, or VCR). If the hum is no longer present, you must insert a "75Ω ground loop isolator" before reconnecting the line. You should check with your ADCOM dealer to obtain one. If the "75Ω ground loop isolator" works only partially or not at all, then please read note 2 to complete the troubleshooting procedure.

Note 2: Make sure that the power amplifier is at least 6" from processor or other equipment using microprocessors. Usually putting another component between them is sufficient to minimize the hum. If this does not reduce the hum, turn the system off and disconnect all Inputs from the amplifier. If the hum still persists, then your dealer or service center must examine the unit/system. If the hum disappears, try another set of RCA cables. Connect one RCA cable at a time to see if one specific cable is responsible. If any or all cables cause the hum to appear, then the unit should be evaluated for proper operation by your dealer or authorized service center. Please see our website or call us for a list of authorized service centers in your area.

Servicing

ADCOM has a technical service department to answer questions pertinent to the installation and operation of your unit. In the event of difficulty, please contact us for prompt advice. If your problem cannot be resolved through our combined efforts, we may refer you to an authorized repair agency, or authorize return of the unit to our factory. To aid us in directing you to a convenient service center, it would be helpful if you indicate which major city is accessible to your home.

Troubleshooting Tip

Your GTP-602's circuitry is built around advanced microprocessors. The GTP-602 may exhibit occasional anomalies arising from AC line surges, etc. If you experience unexpected behavior, or if the GTP-602 "locks up" and does not respond to control input, reset it by turning the rear panel power switch off. (Do not use the remote control's "power" button). Wait 10 seconds and then turn the GTP-602 on using the rear panel power switch.

Please address mail inquires to:

ADCOM Service

8541 East Anderson Drive

Scottsdale, Arizona 85255 USA

Phone, Fax or Email inquires to:

Voice: (480) 607-2277 or Fax: (480) 348-9876

Monday through Friday, 8:00 AM to 4:00 PM MST

Email: service@adcom.com

For fax inquires, please include a return fax number for the reply. When calling or writing about your ADCOM product, be sure to note and refer to its serial number as well as the date of purchase and the dealer from whom it was purchased. In any communications to us, please include a daytime phone number where we may reach you. In the event the unit must be returned to our factory for service, you will be instructed on the proper procedure when you call or write for a return authorization. **Under no circumstances should your unit be shipped to our factory without prior authorization, or packed in other than its original carton and fillers.**

If the original shipping carton and its fillers have been lost, discarded, or damaged, a duplicate carton may be obtained from our service department for a nominal charge.

Always ship prepaid via United Parcel Service (UPS) or other approved carrier. Do not ship via parcel post, since the packing was not designed to withstand rough parcel post handling. Improper shipment of the product will void your warranty coverage.

Warranty

ADCOM, a division of Klein Technology Group, LLC, makes the following limited warranties. These limited warranties extend to the original purchaser or any person receiving this product as a gift from the original purchaser and to no other purchaser or transferee. **There is no warranty provided by ADCOM for products purchased from unauthorized outlets or dealers or from previous owners.**

Limited Five Year Warranty (Home, Non-Commercial Use Only)

ADCOM warrants this product against defects in materials or workmanship for a period of five (5) years after the date of original retail purchase from an ADCOM authorized dealer. During this period, ADCOM will repair or replace a defective product or part, at our option, with a new or refurbished product or part without charge to you, as long as you follow the procedures listed below.

Limited Ninety (90) Day Warranty (Commercial Use Only)

ADCOM warrants this product against defects in materials or workmanship for a period of ninety (90) days after the date of original purchase from an ADCOM authorized dealer. During this period, ADCOM will repair or replace a defective product or part, at our option, with a new or refurbished product or part without charge to you, as long as you follow the procedures listed below.

All implied warranties, including implied warranties of merchantability and fitness for a particular purpose are limited in duration to the duration of the warranty period.

This warranty excludes all incidental and consequential damages, unless contravened by state law. This warranty gives you specific rights and you may have other rights which vary from state to state.

No person, agent, distributor, dealer, or company is authorized to change, modify or extend the terms of these warranties in any manner whatsoever.

Your Responsibilities

The above warranties are subject to the following conditions:

(1) You must retain and present your dated invoice or bill of sale to provide proof of original purchase from an ADCOM Authorized Dealer and coverage under the warranty period.

(2) You must notify us within ten (10) days after you discover a defective product or part.

(3) All warranty servicing of this product must be done by ADCOM or an authorized ADCOM Service Center.

(4) This warranty is only valid if this product has been purchased and used in the United States. Warranty coverage for products purchased and used outside of the United States is provided by local ADCOM authorized distributors.

(5) Charges by third parties for set-up, installation, adjustments, shipment, insurance, and other charges are not covered by this warranty.

(6) This warranty extends only to defects in material or workmanship as limited above and does not extend to any product or part which has been lost or discarded by you, or to damage to products or parts caused by misuse, accident, Acts of God such as lightning or fluctuations in electrical power, improper installation, improper maintenance or use in violation of instructions provided in this Owner's Manual, or to products which have been altered or modified. This warranty does not extend to products which have had the serial number removed, altered, defaced, or rendered illegible.

(7) Physically damaged products are not covered by this warranty and will be returned as received without repair.

GTP-602 Specifications

Input Impedance

Audio 47k Ω

Output Impedance

Audio 550 Ω

Frequency Response

20Hz to 20kHz ± 0.2 dB

THD+Noise at Rated Output

20Hz to 20kHz $\leq 0.005\%$

IM Distortion

CCIF at 15kHz and 16kHz $\leq 0.004\%$

Signal to Noise Ratio (at 1kHz "A" weighted)

Ref. to 1V input, max output voltage > 105 dB

Sensitivity 1 volt output 170mV

Subwoofer Crossover Frequency 100Hz

Crosstalk (@ 1kHz) > 80 dB

Maximum Output Voltage 5.0V

Tone Controls (L and R front only)

Bass effective below 400Hz

Bass Max Gain/Cut +8dB/-10dB @ 20Hz

Treble effective above 1.5kHz

Treble Max Gain/Cut + 8dB/-10dB @ 20Hz

FM Tuner

Usable Mono Sensitivity 15dB μ

50 dB Mono Quieting Sensitivity 22dB μ

50 dB Stereo Quieting Sensitivity 39dB μ

A-wtd. Signal to Noise Ratio

Mono 75dB

Stereo 70dB

Stereo Separation (1 kHz) 43dB

Alternate Channel Selectivity >50 dB

Capture Ratio 2dB

General

Power (user selectable 120/230 VAC) 120VAC/50-60Hz

Chassis Dimension 3.5" (89mm) x 17" (432mm) x 14.75" (375mm)

Maximum Dimensions 4" (102mm) x 17" (432mm) x 16.5" (419mm)

Weight 15 lbs. (6.8kg)

Weight, Packed 20 lbs. (9.1kg)